

Hans J. Wegner / CH\_29 / 1952

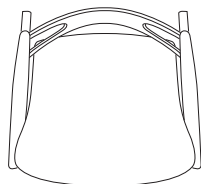

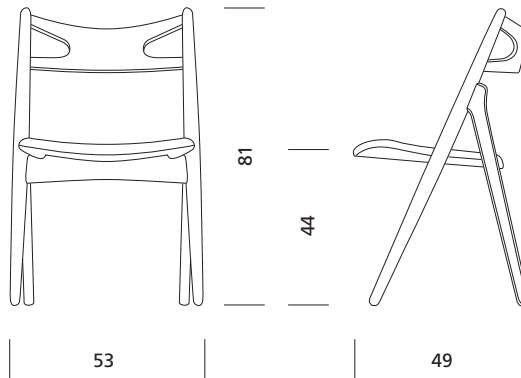

1:20  
Measurements in centimeters

Tel +45 6612 1404\_ info@carlhansen.com  
www.carlhansen.com

1952

Hans J. Wegner \_ CH29